



**WECON**<sup>®</sup>  
WECON TECHNOLOGY CO.,LTD

Factory: 10th Building,E Area,Software Park, Fuzhou,Fujian,China  
Headquarters: 6th Building,F Area,Software Park,Fuzhou,Fujian,China  
Tel: 400-799-8189 Fax: +86-591-87843899  
Website: [www.we-con.com.cn/en](http://www.we-con.com.cn/en)  
Email: [sales@we-con.com.cn](mailto:sales@we-con.com.cn)  
Edition No.: WCT7.1.1



# PRODUCTS CATALOG

Human Machine Interface/Programmable Logic Controller/  
Servo Drive & Motor/IIoT V-BOX/Inverter





WECON TECHNOLOGY CO.,LTD.All Rights Reserved.

WECON is a high technology company on automation and its solution, headquartered in Fuzhou software park, Fujian China. Wecon dedicates all the efforts to provide integrated products and solution on automation, such as Human Machine Interface (HMI), Programmable Logic Controller (PLC), Servo Drive&Motor, IIoT V-BOX and Inverter.

WECON has modernized factory over 10,000 square meters in Fuzhou, the R&D and production department strictly follows ISO9001 quality management system, and all products are certificated by CE and FCC. The R&D center has more than 3,000 square meters in Fuzhou, with more than 150 R&D engineers work here.

Until July 1st 2021, WECON have been authorized over 100 independent intellectual property rights, which includes 4 Invention Patents, 15 Utility patents, 9 Design Patents, and 72 software intellectual property rights. WECON has over 40 domestic offices all over China, more than 30 foreign distributors in 22 countries. WECON business covers most main industrial countries, locating in Asia, Europe, North America, South America, Oceania and Africa.

2019 is an important year of WECON globalization. In this time, we start to have international employees, now have employees from Turkey, Egypt, and Brazil. They are dedicated efforts and wisdom to support customers success and improve the industry level of the world. WECON provides services such as technical support and maintenance all over the world. Overseas customers could buy products and enjoy services locally and conveniently.

Wecon have opened local offices for sales and support in Turkey, Egypt and Brazil. Wecon have plan to open more than 10-15 offices in other countries within 2 years.

# Content

<b>About WECON</b>	01	<b>WECON SERVO Drives</b>
<b>WECON Products</b>	03	Servo Drives Features .....29
<b>WECON HMI</b>		Servo Applications ..... 30
HMI Features ..... 05		Servo Naming Rules ..... 31
ig Series IoT HMI ..... 06		VD2/VD2F Servo Driver&Motor Specifications..... 32
PI8150ig High Definition IoT HMI..... 07		VD2 Servo Specifications ..... 33
PI3000ie Series HMI ..... 08		
ig Specifications ..... 09		<b>WECON V-NET&amp;V-BOX</b>
PI3000ie Specifications ..... 12		V-NET Architecture ..... 35
PI3000i Specifications ..... 13		V-NET Functions..... 36
<b>WECON PLC</b>		V-BOX Features ..... 37
PLC Features ..... 15		V-BOX Applications ..... 38
PLC Applications ..... 16		V-BOX E Series Specifications ..... 39
LX6V Series PLC ..... 17		V-BOX H Series Specifications ..... 40
LX5V Series PLC ..... 19		
LX5S Series PLC ..... 20		<b>INVERTER</b>
Expansions Modules&BD Modules..... 21		VB Series AC Drive ..... 41
LX5V&LX5S PLC Specifications ..... 22		Specifications ..... 42
LX3V Series PLC Specifications ..... 23		Dimensions ..... 44
LX5V General Specifications ..... 25		
LX5S General Specifications ..... 26		<b>WECON APPLICATIONS</b>
PLC General Specifications ..... 27		IoT Applications ..... 45

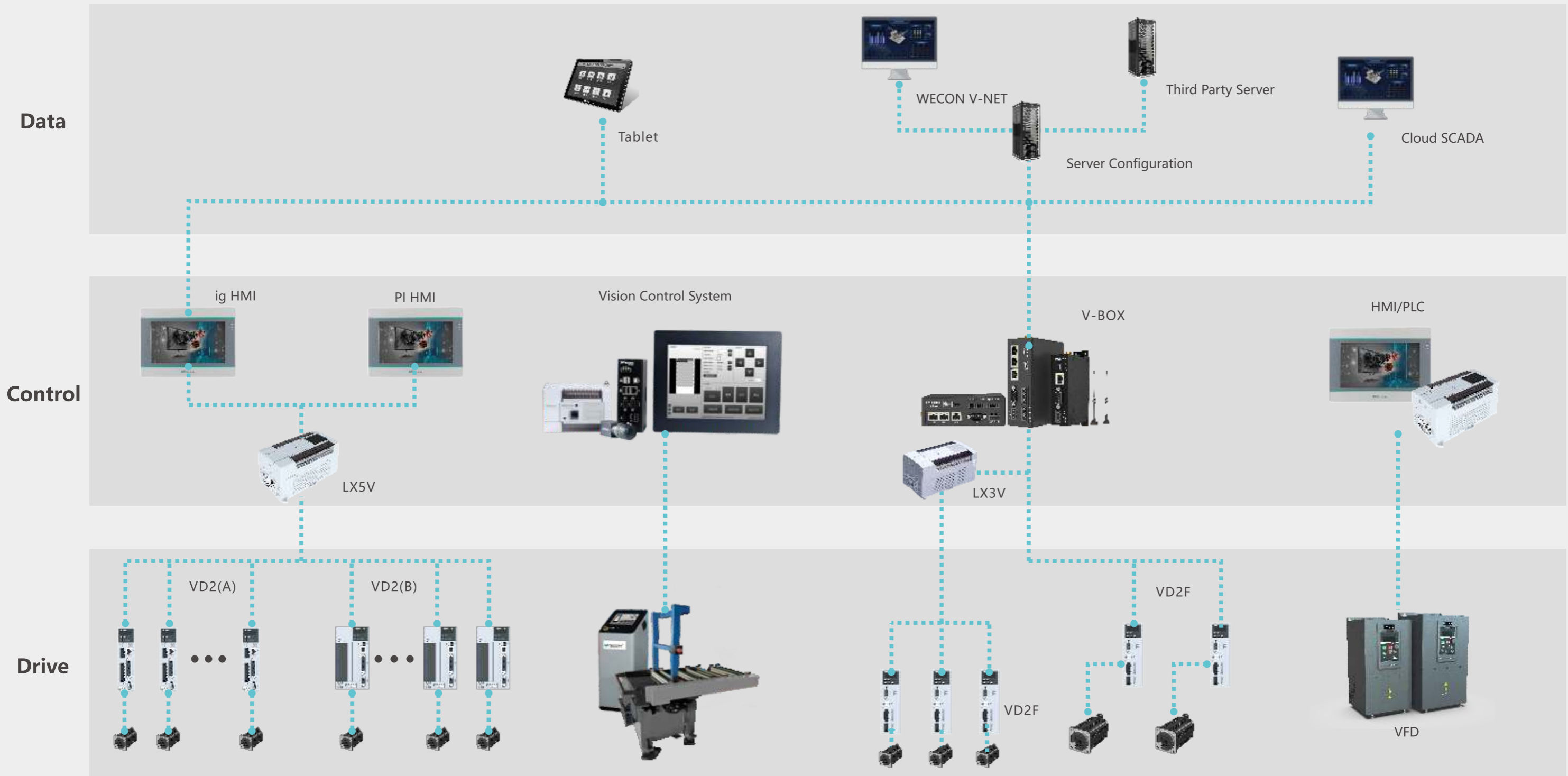

Smart Treatment for Water



Smart Factory



Automatic Plug Wiring Machine



Textile Machinery



# WECON HMI



# ig Series IoT HMI

ig IoT HMI, create for the Internet of Things



## Installment



Installment function  
Users can set fixed installment or dynamic installment in HMI in advance to help customers effectively recover the unsettled balance within a certain period of time.

## HMI Recipe



Users can configure the recipe file data on the HMI, and easily switch between different production modes.

## Device Management

- Multi-device management
- Multi-authority account



## Alarm Notification

- Alarm SMS push(4G models)
- Upload and download alarm records



## User Permission Management



The HMI project can set the user permission and usage permission for different users to protect operation of the device.

## Multi-language Display



Wecon HMI supports maximum 8 languages, facilitating the use of WECON HMI in many countries.

## Remote Maintenance

- Sync data to cloud
- Remote access
- WVPN pass-through
- Remote debug



## System Integration

- Cloud SCADA
- Big screen display
- Equipment connection



# PI8150ig High Definition IoT HMI

Aluminium Alloy Panel



High-definition  
Wide Viewing Angle

# PI3000ie Series HMI

Quad Core CPU  
Fast and Fluent Touch



## Big Screen

More convenient operation  
Display in high-definition and high quality



1920×1080

## Aluminium Alloy Panel

Strong anti-interference, excellent heat dissipation  
Anti-corrosion, and high temperature resistance



## Fast



6 seconds for booting  
100ms for screen switch

## Numerous



300+ communication protocols  
50+ objects

## 4-core CPU

With Cortex A35 1.2GHz high performance processor  
PI8150ig has powerful operation processing capability



## Complete IoT Functions

MQTT cloud protocol and database server connection  
Supported more powerful IoT functions

- Real-time Monitoring Points: 300
- Alarm Monitoring Points: 200
- History Monitoring Points: 100
- History Storage: 120 days / 1 millions



## Unique



Unique installment function  
Unique user permission management  
Unique data encryption function

## Reliable



Enhance software security  
Better communication Stability  
Waterproof and heat cooling

# ig SPECIFICATIONS

# ig SPECIFICATIONS

## Basic HMI



Model	PI3070ig	PI3102ig	PI8150ig
-------	----------	----------	----------

Item	Specifications		
CPU	Cortex A35 1.2GHz		
Touch Screen	Resistive		
Display	Screen Size	7 Inch	10.2 Inch
	Resolution	800*480	1024*600
	Brightness	250 cd/m <sup>2</sup>	350 cd/m <sup>2</sup>
	Backlight Type	LED	
	Backlight Life	50,000 Hours	
	Colors	16,000k colors	2,60k colors
Storage	Flash	128 MB	4GB
	RAM	DDRIII 128MB	DDRIII 512MB
	SD Card	YES	YES (TF card)
I/O Port	USB	USB Host: USB 2.0 x 1; USB Client: USB 2.0 x 1 (cannot be used at the same time)	
	Serial Port	Type 1: COM1(RS232), COM1(RS485), COM1(RS485) Type 2: COM1(RS232), COM1(RS422), COM1(RS485)	
	Ethernet	YES	
	CAN	N/A	
	4G/WIFI Module	Optional	
Permanent Calendar	Built-in		
Power	Power Supply	24V DC (12~28V DC)	24V DC (18~28VDC)
	Power Consumption	<8W	<10W
Dimension	Enclosure	Plastic+ABS (Polycarbonate)	Aluminum + Metal + ABS
	Dimension(mm)	201.2W*147.2H*39.0D	272.0W*191.0H*41.5D
	Mounting Size(mm)	192.0W*138.0H	260.0W*179.0H
	Net Weight (KG)	0.52	1.02
Environment	Protection	IP65 (Front panel)	
	Temperature	Storage: -20℃~70℃ Working: -10℃~55℃	Storage: -20℃~60℃ Working: 0℃~50℃
	Humidity	10 ~ 90%RH (Non-condensing)	
	Vibration Resistance	10 ~ 25 Hz (X, Y, Z direction 2G/30 minutes)	
CE Certification	CE Marked		
FCC Certification	FCC Class A		
Programming Software	PI Studio		
Software	IoT Service (optional)	Real-time Monitoring Points: 100	Real-time Monitoring Points: 300
		Alarm Monitoring Points: 20	Alarm Monitoring Points: 200
		History Monitoring Points: 50	History Monitoring Points: 100
	VPN Pass-through	History Storage: 60 days / 1 millions	History Storage: 120 days / 1 millions
		YES	

## Basic HMI



Model	PI3070ig-O	PI3102ig-O
-------	------------	------------

Item	Specifications	
CPU	Cortex A35 1.2GHz	
Touch Screen	Resistive	
Display	Screen Size	7 Inch
	Resolution	800*480
	Brightness	250 cd/m <sup>2</sup>
	Backlight Type	LED
	Backlight Life	50,000 Hours
	Colors	16,000k colors
Storage	Flash	128 MB
	RAM	DDRIII 128MB
	SD Card	YES
I/O Port	USB	USB Host: USB 2.0 x 1; USB Client: USB 2.0 x 1 (cannot be used at the same time)
	Serial Port	Type 1: COM1(RS232), COM1(RS485), COM1(RS485) Type 2: COM1(RS232), COM1(RS422), COM1(RS485)
	Ethernet	YES
	CAN	N/A
	4G/WIFI Module	N/A
Permanent Calendar	Built-in	
Power	Power Supply	24V DC (12~28V DC)
	Power Consumption	<8W
Dimension	Enclosure	Plastic+ABS (Polycarbonate)
	Dimension(mm)	201.2W*147.2H*39.0D
	Mounting Size(mm)	192.0W*138.0H
	Net Weight (KG)	0.52
Environment	Protection	IP65 (Front panel)
	Temperature	Storage: -20℃~70℃; Working: -10℃~55℃
	Humidity	10 ~ 90%RH (Non-condensing)
	Vibration	10 ~ 25 Hz (X, Y, Z direction 2G/30 minutes)
CE Certification	CE Marked	
FCC Certification	FCC Class A	
Programming Software	PI Studio	
Remote Control	N/A	

# PI3000ie SPECIFICATIONS

## Basic HMI



Model	PI3035ie	PI3043ie	PI3043ieS-N
-------	----------	----------	-------------

Item	Specifications		
CPU	Cortex A35 1.2GHz		
Touch Screen	Resistive		
Display	Screen Size	3.5 Inch	4.3 Inch
	Resolution	320*240	480*272
	Brightness	300cd/ m <sup>2</sup>	
	Backlight Type	LED	
	Backlight Life Time	50,000 Hours	
	Colors	16,000k colors	
Storage	Flash	128MB	
	RAM	DDRII 64MB	
	SD Card	N/A	
	RTC	Real Time Clock	
I/O Port	Micro-USB	USB 2.0 x 1	
	Serial Port	Type 1: COM1(RS232), COM1(RS485)	Type 1: COM1(RS232), COM1(RS485)
		Type 2: COM1(RS232), COM1(RS422)	Type 2: COM1(RS232), COM1(RS422), COM1(RS485)
	Ethernet	N/A	YES
	Permanent Calendar	Built-in	
Power	Power Supply	24V DC(12~28V DC)	
	Power Consumption	< 5W	
Dimension	Enclosure	Plastic+ABS (Polycarbonate)	
	Dimension(mm)	96.0W*81.0W*33D	142.0W*86.0H*30.3D
	Mounting Size (mm)	91.0W*73.0D	131.0W*78.0H
	Net Weight (KG)	0.14	0.19
Environment	Protection	IP65 (Front panel)	
	Temperature	Storage: -20℃~70℃ ; Working: -10℃~55℃	
	Humidity	10 ~ 90%RH (Non-condensing)	
	Vibration Resistance	10 ~ 25 Hz (X, Y, Z direction 2G/30 minutes)	
CE Certification	CE Marked		
Programming Software	PI Studio		
Remote Control	N/A		

# PI3000ie SPECIFICATIONS

## Basic HMI



Model	PI3070ie	PI3102ie
-------	----------	----------

Item	Specifications	
CPU	Cortex A35 1.2GHz	
Touch Screen	Resistive	
Display	Screen Size	7 Inch
	Resolution	800*480
	Brightness	250 cd/m <sup>2</sup>
	Backlight Type	LED
	Backlight Life Time	50,000 Hours
	Colors	16,000k colors
Storage	Flash	128MB
	RAM	DDRII 64MB
	SD Card	NA
	USB	USB Host: USB 2.0 x 1 ; USB Client: USB 2.0 x 1
Ports	Serial Port	Type 1: COM1(RS232), COM1(RS485) Type 2: COM1(RS232), COM1(RS422)
	Ethernet	N/A
	Permanent Calendar	Built-in
Power	Power Supply	24V DC(12~28V DC)
	Power Consumption	< 8W
Dimension	Enclosure	Plastic+ABS (Polycarbonate)
	Dimension(mm)	201.2W*147.2H*39.0D
	Mounting Size (mm)	192.0W*138.0H
	Net Weight (KG)	0.52
Environment	Protection	IP65 (Front panel)
	Temperature	Storage: -20℃~70℃ ; Working: -10℃~55℃
	Humidity	10 ~ 90%RH(Non-condensing)
	Vibration Resistance	10 ~ 25 Hz (X, Y, Z direction 2G/30 minutes)
CE Certification	CE Marked	
Programming Software	PI Studio	
Remote Control	N/A	

# PI3000i SPECIFICATIONS

## Basic HMI



### Model

PI3070i    PI3070i-2S    PI3070i-A    PI3070i-SL    PI3070i-SL-N

Item	Specifications					
CPU	Cortex A7 528MHz					
Touch Screen	Resistive					
Display	Screen Size	7 Inch				
	Resolution	800*480				
	Brightness	250 cd/m <sup>2</sup>				
	Backlight Type	LED				
	Backlight Life Time	50,000 Hours				
	Colors	16,000k colors				
Storage	Flash	128MB				
	RAM	DDRIII 128MB				
	SD Card	NA	YES	YES	NA	NA
	RTC	YES				
I/O Ports	USB	USB Host: USB 2.0 x 1; USB Client: USB 2.0 x 1				
	Serial Port	RS232, RS422/RS485 (2 in 1)	COM1: RS232,RS422/RS485		RS232, RS422/RS485 (2 in 1)	
			COM2: RS232,RS485			
			COM3: RS485			
	Ethernet	N/A	YES	YES	N/A	YES
CAN	N/A	N/A	YES	N/A	N/A	
Permanent Calendar	Built-in					
Power	Power Supply	24V DC(12~28V DC)				
	Power	< 8W				
Dimension	Enclosure	Plastic+ABS (Polycarbonate)				
	Dimension(mm)	201.2W*147.2H*39.0D	200.0W*146.0H*36.5D		191.2W*137.2H*41.0D	
	Mounting Size	192.0W*138.0H	192.0W*138.0H		172.0W*111.0H	
	Net Weight (KG)	0.51	0.51		0.52	
Environment	Protection	IP65 (Front panel)				
	Temperature	Storage: -20℃~70℃; Working: -10℃~55℃				
	Humidity	10 ~ 85%RH(Non-condensing)				
	Vibration	10 ~ 25 Hz (X, Y, Z direction 2G/30 minutes)				
CE Certification	CE Marked					
FCC Certification	FCC Class A					
Programming Software	PI Studio					
Remote Control	N/A					

# PI3000i SPECIFICATIONS

## Basic HMI



### Model

PI3102i    PI3102i-2S    PI3102i-A

Item	Specification			
CPU	Cortex A7 528MHz			
Touch Screen	Resistive			
Display	Screen Size	10.2inch		
	Resolution	1024*600		
	Brightness	350 cd/m <sup>2</sup>		
	Backlight Type	LED		
	Backlight Life	50,000 Hours		
	Colors	16,000k colors		
Storage	Flash	128MB		
	RAM	DDRIII 128MB		
	SD Card	YES		
	RTC	YES		
I/O Port	USB	USB Host: USB 2.0 x 1; USB Client: USB 2.0 x 1		
	Serial Port	RS232, RS422/RS485 (2 in 1)	COM1: RS232,RS422/RS485	COM1: RS232 ,RS422/RS485, CAN
			COM2: RS232,RS485	COM2: RS232,RS485
			COM3: RS485	COM3: RS485
	Ethernet	YES		
	CAN	N/A	YES	
Permanent Calendar	Built-in			
Power	Power Supply	24V DC(12~28V DC)		
	Power Consumption	<10W		
Dimension	Enclosure	Plastic+ABS (Polycarbonate)		
	Dimension(mm)	272.0W * 191.0H * 41.5D	272.0W * 190.7H * 41.3D	
	Mounting Size(mm)	260.0W * 179.0H		
	Net Weight (KG)	1.00KG	1.2KG	
Environment	Protection	IP65 (Front panel)		
	Temperature	Storage :-20℃~70℃; Working :-10℃~55℃		
	Humidity	10 ~ 85%RH (Non-condensing)		
	Vibration	10 ~ 25 Hz (X, Y, Z direction 2G/30 minutes)		
CE Certification	CE Marked			
FCC Certification	FCC Class A			
Programming Software	PI Studio			
Remote Control	N/A			





## PLC Applications

### Automatic Plug Wiring Machine



#### Fast Scan

Program scanning speed: 0.2ms

#### Efficient Work

The line is 1.8m-2m, 1250 lines/hour  
The line is 1.3 meters, 1300 lines/hour

### High Speed Pulse Input/Output

- Supports pulse + direction mode input
- Supports high speed pulse output with acceleration and deceleration
- The acceleration and deceleration time are configurable

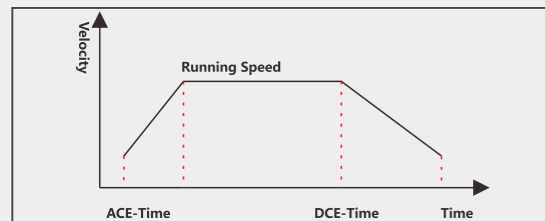

### Modbus Listed Instruction

- RSLIST+RSLIST list
- Easier protocols communication

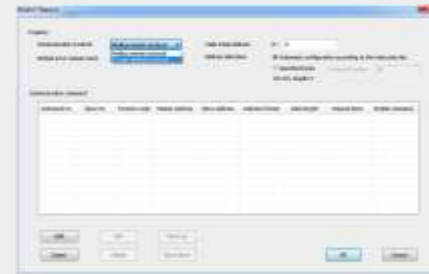

### Program Encryption

- Subroutine encryption
- Ladder encryption
- PLC unit and PLC project encryption



### PLC Guide Function

- PID operation guide setting
- All module guide setting
- All BD Board guide setting

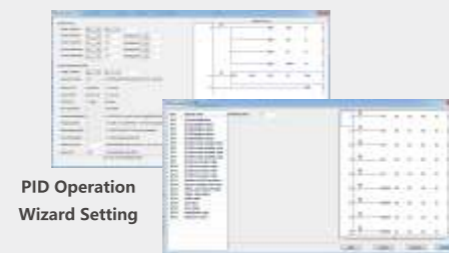

## Application

Rail Transport, Packaging Machinery, Automated Production Lines, Grinding Machine, Industrial Robots, Spray and Dust Prevention, Elevator, Textile Machinery

### Grinding Machine



### Textile Machinery



### Industrial Robots



### Elevator



# LX6V series PLC

## New Launched Modular EtherCAT PLC

Multi-port, fast communication, brand new product

- Supports EtherCAT and USB TYPE-C
- Supports 61131-3LD programming mode, free label protocol, faster and more efficient communication
- Nice appearance of PLC and module



LX6V series PLC, small size and large capacity, a new evolution to bus PLC

### Software upgrade

- Newly designed overall encryption scheme
- Newly designed free tag protocol
- Compatible with 5V 61131-3 LD program
- Custom FB/FC
- Global variable definition
- EtherCAT configuration
- EtherNET configuration

### Capacity upgrade

- 5MB large program capacity
- 512KB latched capacity
- 100KB register capacity
- 5MB free tag capacity

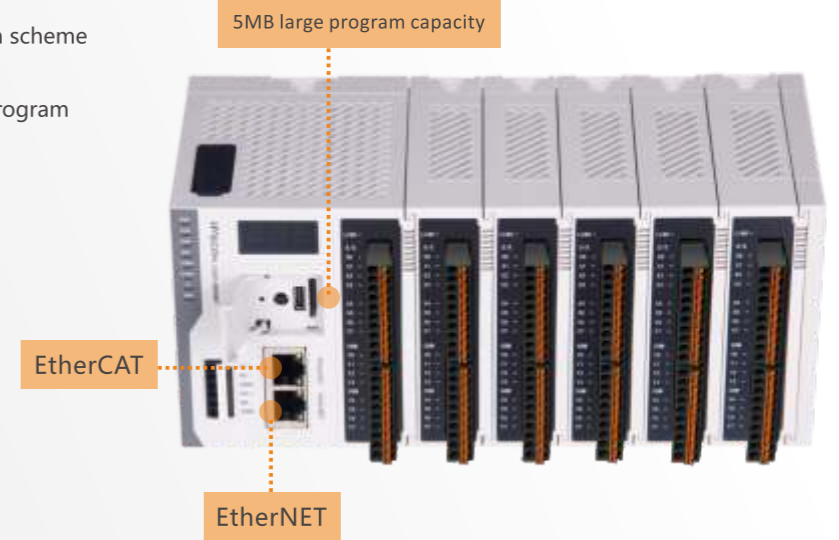

## PLC General

Item	LX6V-0808MT/1616MT
Running Mode	Cycle Scan/ Interrupt
Programming	Instruction table/ladder diagram/FB/FC
Total Instructions	Basic instruction: 29 / Application instruction: 170
Execute Time	Basic instruction 0.01-0.02μs
System Storage	5MB
Download/ Monitoring	Programming cable(serial port)
	ETHERNET USB TYPE-C
High Speed Pulse Output	Transistor type 4 channels/200KHz
High speed counter interrupt	100 channels
Timer Interrupt	100 channels, support 0.1ms interrupt
External input interrupt	X0-X7 supports both rising and falling edges
High Speed Input Single	4 channels 150 KHz
High Speed Input AB Phase	4 channels 100K Hz, supports 2 or 4 frequency multiplication
Power-down Save	Adjusted by software
Storage	EMMC
Filter	For all the input terminals
Serial Port	COM1 (RS485) 、COM2 (RS485)
Temperature	Working Temperature : 0 ~ 55°C / Storage Temperature : 0 ~ 70°C
Humidity	35~ 85%RH (Without condensation)
Shock Resistance	JISC0040 Standard
Influence Immunity	Meet the IEC61000-4-4 and GB/T 17626.4 standard: Noise voltage amplitude 1KVP-P, pulse width 10us, period 0.3s, edge time 5ns.
TF	Support
ETHERNET	1000M Ethernet
ETHERCAT	250μs 8-axis servo axis ~ 2ms 64-axis servo axis

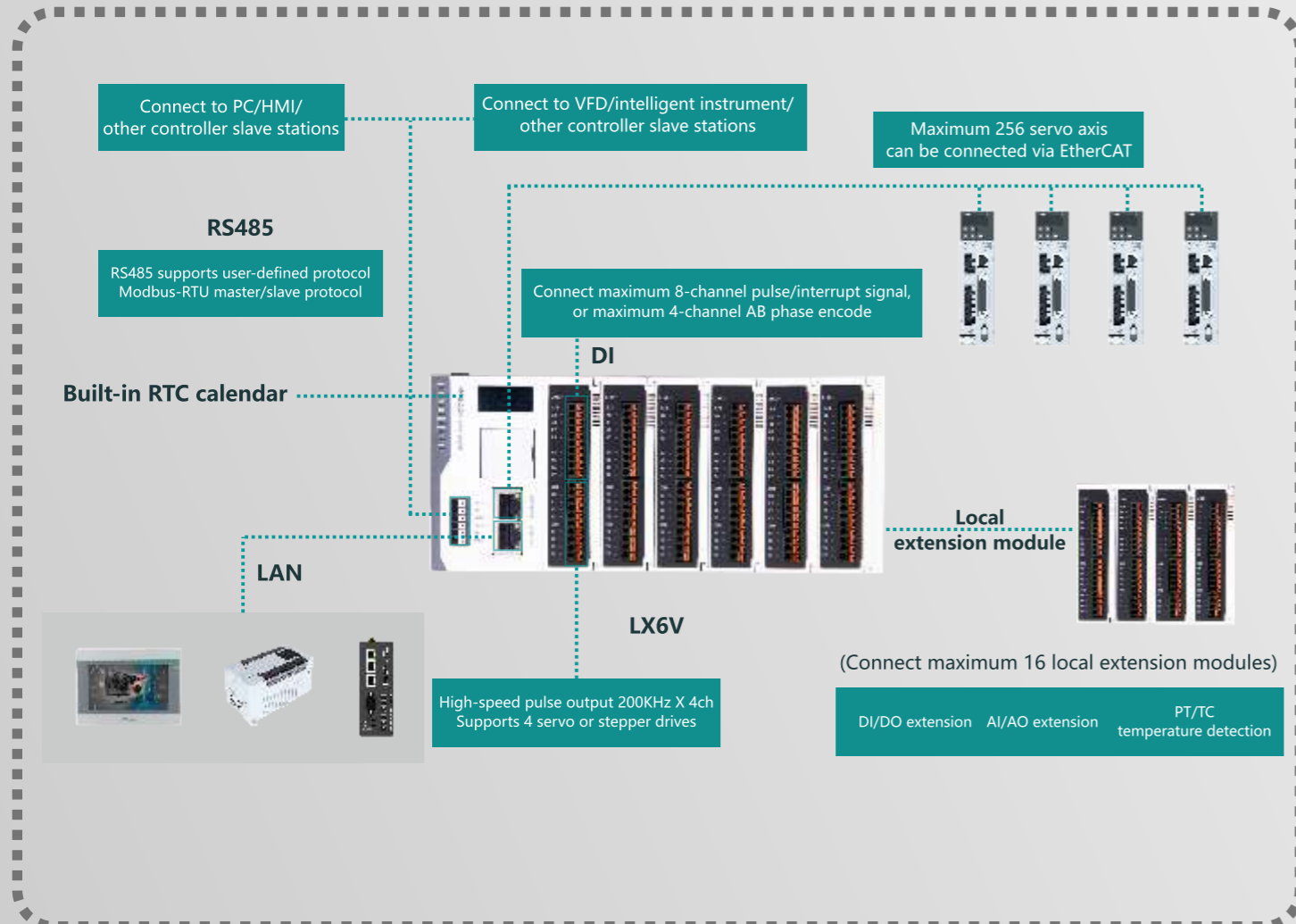

## LX5V Series PLC



## LX5S Series PLC



### 8 Channel Pulse Input/Output

- 8 channels high speed counter ;
- 8 channels high speed pulse input, 150KHZ high-speed counter;
- 8 channels high speed pulse output, 200KHZ high-speed pulse output;
- Fast and accurate control.

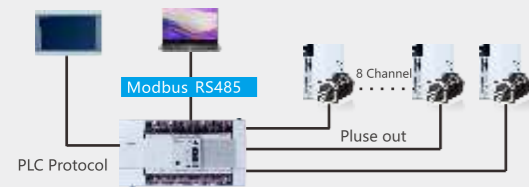

### Fast

- 0.01us~0.03us for basic instruction execution ;
- Supports 8 channels external X interrupt;
- Support both rising edge and falling edge.



### Easy Programming

- Friendly interface;
- Clear program classification;
- Detailed and clear parameter configuration.



### Functions

- Support to modify frequency and position during pulse running;
- Support the highest baud rate: 921600;
- Support 100us high-speed timer interrupt;
- Support up to 100 high-speed counter interrupt;
- Support E-CAM;
- Support electronic gear;
- Support efficient and stable PID and CCPID self-tuning;
- Support BD module of LX 3V series (3V Communication BD module not supported);
- USB power supply.

### Functions

- Support to modify frequency and position during pulse running;
- Support the highest baud rate: 921600;
- Support 100us high-speed timer interrupt;
- Support up to 100 high-speed counter interrupts;
- Support E-CAM;
- Support electronic gear;
- Support efficient and stable PID and CCPID self-tuning;
- Support LX 3V series modules;
- USB power supply;
- LX5V Software;
- 0.03us~0.08us for basic instruction execution.

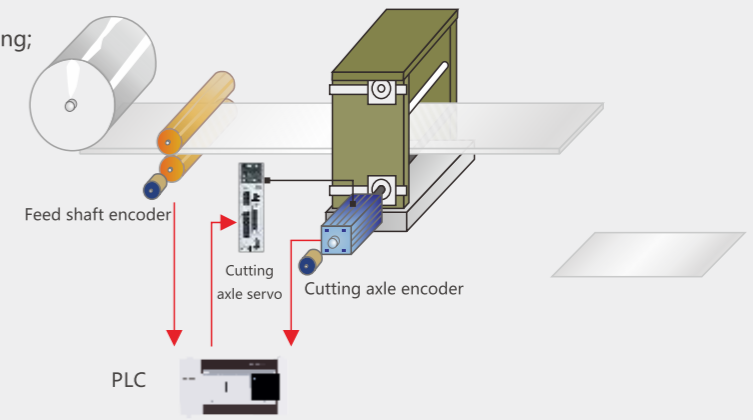

E-cam -- Flying shear function

### More Registers

- 512KB program capacity;
- 76KB latched capacity;
- 76KB register capacity;
- Added 128 timers of 0.1ms;
- Added 128 timers of 1ms.

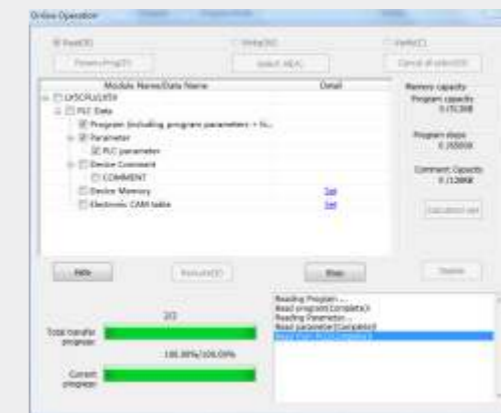

# Expansion Modules & BD Modules

## LX3V Expansion Modules

Module	Specification	Module	Specification	
I/O	LX3V-8EX	Analog	LX3V-4AD	4 * Analog Input
	LX3V-8EYR		LX3V-4DA	4 * Analog Output
	LX3V-8EYT		LX3V-4PT	4 * Thermal Resistance Input
	LX3V-16EX	Temperature	LX3V-4TC	4 * Thermocouple Input
	LX3V-16EYR		LX3V-4LTC	4 * TC with Isolation (PID Control)
	LX3V-16EYT		LX3V-8iTC	8 * Thermocouple Input
Weighting	LX3V-1WT	Weighting	LX3V-2WT	2 * Weighting (24-bit)
	LX3V-1WT-L		LX3V-2WT-L	2 * Weighting (18-bit)
High Speed Pulse Output	LX3V-4PGA	High Speed Pulse Output	LX3V-4PGB	Supports 4*200KHZ high-speed pulse output. Supports T, S curve acceleration and deceleration. Supports two-speed positioning and interrupt one-speed positioning. Supports variable speed operation. Supports single-speed positioning.
Remote	LCM-16EX	Remote	LCM-2WT	2 * weighing expansion module, 24-bit resolution, supports RS485 Modbus communication.
	LCM-16EYR		LCM-4TC	4 * thermocouple Input, supports RS485 Modbus communication.

## LX3V SERIES BD Modules

BD Board	Function	BD Board	Function
LX3V-2ADI2DAI-BD	2 * Analog Input/ Analog Output (4~20mA)	LX3V-2PT-BD	2 * Thermal Resistance Input
LX3V-2TC2DAI-BD	2 * Thermocouple Input ; 2 * Analog Output (4~20mA)	LX3V-2PT2ADV-BD	2 * Thermal Resistance Input ; 2 * Analog Voltage input(-10V-10V)
LX3V-2PT2DAI-BD	2 * Thermal Resistance Input ; 2 * Analog Output (4~20mA)	LX3V-2PT2DAV-BD	2 * Thermal Resistance Input ; 2 * Analog Voltage Output(-10V-10V)
LX3V-2TC-BD	2 * Thermocouple Input	LX3V-2ADV2DAV-BD	2 * Analog Input/ Output (-10V~10V)
LX3V-4ADI-BD	4 * Analog Input (4~20mA)	LX3V-2RS485-BD	2 * RS485 Communication
LX3V-4ADV-BD	4 * Analog Input (-10V~10V)	LX3VP-ETH-BD	1 * Ethernet Communication
LX3V-2ADV-BD	2*Analog Voltage Input(-10V-10V)	LX3V-2DAI-BD	2*Analog Current Output(4-20mA)
LX3V-2ADI-BD	2*Analog Current Input(4-20mA)	LX3V-2DAV-BD	2*Analog Voltage Output(-10V-10V)
LX3V-2PTS-BD	2* Thermal Resistance Input, Precision >0.1°C		

## LX5V SERIES BD Modules

BD Board	Function	BD Board	Function
LX5V-8BYT-BD	8 * DO Output (Transistor NPN output)	LX5V-2RS485-BD	2 * RS485 Communication
LX5V-8BX-BD	8 * DI Input	LX5V-ETH-BD	1 * Ethernet Communication
LX5V-2ADV-BD	2*Analog Voltage Input (-10v-10v)	LX5V-4ADV-BD	4 * Analog Input (-10V~10V)
LX5V-2ADI-BD	2*Analog Current Input (4-20mA)	LX5V-4ADI-BD	4 * Analog Input (4~20mA)
LX5V-2DAV-BD	2*Analog Voltage Output (-10v-10v)	LX5V-2ADV2DAV-BD	2 * Analog Input/ Output (-10V~10V)(-10V~10V)
LX5V-2DAI-BD	2*Analog Current Output (4-20mA)	LX5V-2ADI2DAI	2 * Analog Input/ Analog Output (4~20mA)
LX5V-2PT-BD	2 * Thermal Resistance Input, Precision =0.2~0.3°C	LX5V-2PT2ADV-BD	2 * Thermal Resistance Input ; 2 * Analog Voltage input(-10v-10v)
LX5V-2PTS-BD	2 * Thermal Resistance Input, Precision =0.1°C	LX5V-2PT2DAI-BD	2 * Thermal Resistance Input ; 2 * Analog Output (4~20mA)
LX5V-2TC-BD	2 * Thermocouple Input(K Type, J Type)	LX5V-2PT2DAV-BD	2 * Thermal Resistance Input ; 2 * Analog Voltage Output(-10v-10v) (-10V-10V)
LX5V-2TC2DAI-BD	2 * Thermocouple Input(K Type, J Type) ; 2 * Analog Output (4~20mA)		

# LX5V & LX5S PLC Specifications

## LX5V PLC Model

LX5V Model	I/O	Output Type	Dimension (mm)	Pulse Counter	E-CAM	Pulse Output	RS485	BD Board	Module	Power Supply	Ethernet
LX5V-1412MT-A(D/AN/DN)	14/12	Transistor	137x107x87	4	YES	4	2	1	YES	AC(DC)	Optional
LX5V-1616MT-A(D/AN/DN)	16/16	Transistor	175x107x87	8	YES	8	2	2	YES	AC(DC)	Optional
LX5V-2416MT-A(D/AN/DN)	24/16	Transistor	175x107x87	8	YES	8	2	2	YES	AC(DC)	Optional
LX5V-2424MT-A(D/AN/DN)	24/24	Transistor	220x107x87	8	YES	8	2	2	YES	AC(DC)	Optional
LX5V-3624MT-A(D/AN/DN)	36/24	Transistor	220x107x87	8	YES	8	2	2	YES	AC(DC)	Optional

## LX5S PLC Model

LX5S Model	I/O	Output Type	Dimension (mm)	Pulse Counter	E-CAM	Pulse Output	RS485	BD Board	Module	Power Supply	Ethernet
LX5S-0806MT-A(D)	08/06	Transistor	75x107x87	2	YES	2	1	1	N/A	AC(DC)	N/A
LX5S-0806MR-A(D)	08/06	Relay	75x107x87	2	N/A	0	1	1	N/A	AC(DC)	N/A
LX5S-0806MR2H-A(D)	08/06	Mix	75x107x87	2	YES	2	1	1	N/A	AC(DC)	N/A

LX5S-1208MT-A(D)	12/08	Transistor	75x107x87	2	YES	2	1	1	N/A	AC(DC)	N/A
LX5S-1208MR-A(D)	12/08	Relay	75x107x87	2	N/A	0	1	1	N/A	AC(DC)	N/A
LX5S-1208MR2H-A(D)	12/08	Mix	75x107x87	2	YES	2	1	1	N/A	AC(DC)	N/A

LX5S-1412MT-A(D/AN/DN)	14/12	Transistor	137x107x87	2	YES	2	2	1	YES	AC(DC)	Optional
LX5S-1412MR-A(D/AN/DN)	14/12	Relay	137x107x87	2	N/A	0	2	1	YES	AC(DC)	Optional
LX5S-1412MR2H-A(D/AN/DN)	14/12	Mix	137x107x87	2	YES	2	2	1	YES	AC(DC)	Optional

LX5S-1616MT-A(D/AN/DN)	16/16	Transistor	175x107x87	6	YES	2	2	2	YES	AC(DC)	Optional
LX5S-1616MR-A(D/AN/DN)	16/16	Relay	175x107x87	6	N/A	0	2	2	YES	AC(DC)	Optional
LX5S-1616MR2H-A(D/AN/DN)	16/16	Mix	175x107x87	6	YES	2	2	2	YES	AC(DC)	Optional
LX5S-1616MT4H-A(D/AN/DN)	16/16	Transistor	175x107x87	6	YES	4	2	2	YES	AC(DC)	Optional

LX5S-2416MT-A(D/AN/DN)	24/16	Transistor	175x107x87	6	YES	2	2	2	YES	AC(DC)	Optional
LX5S-2416MR-A(D/AN/DN)	24/16	Relay	175x107x87	6	N/A	0	2	2	YES	AC(DC)	Optional
LX5S-2416MR2H-A(D/AN/DN)	24/16	Mix	175x107x87	6	YES	2	2	2	YES	AC(DC)	Optional
LX5S-2416MT4H-A(D/AN/DN)	24/16	Transistor	175x107x87	6	YES	4	2	2	YES	AC(DC)	Optional

LX5S-2424MT-A(D/AN/DN)	24/24	Transistor	220x107x87	6	YES	2	2	2	YES	AC(DC)	Optional
LX5S-2424MR-A(D/AN/DN)	24/24	Relay	220x107x87	6	N/A	0	2	2	YES	AC(DC)	Optional
LX5S-2424MR2H-A(D/AN/DN)	24/24	Mix	220x107x87	6	YES	2	2	2	YES	AC(DC)	Optional
LX5S-2424MT4H-A(D/AN/DN)	24/24	Transistor	220x107x87	6	YES	4	2	2	YES	AC(DC)	Optional

LX5S-3624MT-A(D/AN/DN)	36/24	Transistor	220x107x87	6	YES	2	2	2	YES	AC(DC)	Optional
LX5S-3624MR-A(D/AN/DN)	36/24	Relay	220x107x87	6	N/A	0	2	2	YES	AC(DC)	Optional
LX5S-3624MR2H-A(D/AN/DN)	36/24	Mix	220x107x87	6	YES	2	2	2	YES	AC(DC)	Optional
LX5S-3624MT4H-A(D/AN/DN)	36/24	Transistor	220x107x87	6	YES	4	2	2	YES	AC(DC)	Optional

# LX3V Series PLC Specifications

## LX3V PLC Model

LX3V Model	I/O	Output Type	Dimension (mm)	Pulse Counter	Pulse Output	RS485	BD Board	Module	Power Supply
LX3V-0806MR-A1 (D1)	08/06	Relay	75x107x87	2	0	1	1	N/A	AC (DC)
LX3V-0806MT-A1 (D1)	08/06	Transistor	75x107x87	2	2	1	1	N/A	AC (DC)
LX3V-0806MR-A2 (D2)	08/06	Relay	75x107x87	2	0	1	1	N/A	AC (DC)
LX3V-0806MT-A2 (D2)	08/06	Transistor	75x107x87	2	2	1	1	N/A	AC (DC)
LX3V-1208MR-A1 (D1)	12/08	Relay	75x107x87	2	0	1	1	N/A	AC (DC)
LX3V-1208MT-A1 (D1)	12/08	Transistor	75x107x87	2	2	1	1	N/A	AC (DC)
LX3V-1208MR-A2 (D2)	12/08	Relay	75x107x87	2	0	1	1	N/A	AC (DC)
LX3V-1208MT-A2 (D2)	12/08	Transistor	75x107x87	2	2	1	1	N/A	AC (DC)
LX3V-1208MR2H--A2 (D2)	12/08	Mix	75x107x87	2	2	1	1	N/A	AC (DC)
LX3V-1412MR-A (D)	14/12	Relay	137x107x87	2	0	2	1	YES	AC (DC)
LX3V-1412MT-A (D)	14/12	Transistor	137x107x87	2	2	2	1	YES	AC (DC)
LX3V-1412MT4H-A (D)	14/12	Transistor	137x107x87	2	4	2	1	YES	AC (DC)
LX3V-1412MR2H-A (D)	14/12	Mix	137x107x87	2	2	2	1	YES	AC (DC)
LX3V-1616MR-A (D)	16 / 16	Relay	175x107x87	2	0	2	2	YES	AC (DC)
LX3V-1616MT-A (D)	16 / 16	Transistor	175x107x87	2	2	2	2	YES	AC (DC)
LX3V-1616MT4H-A (D)	16 / 16	Transistor	175x107x87	2	4	2	2	YES	AC (DC)
LX3V-1616MR2H-A (D)	16 / 16	Mix	175x107x87	2	2	2	2	YES	AC (DC)
LX3V-2416MR-A (D)	24 / 16	Relay	175x107x87	2	0	2	2	YES	AC (DC)
LX3V-2416MT-A (D)	24 / 16	Transistor	175x107x87	2	2	2	2	YES	AC (DC)
LX3V-2416MT4H-A (D)	24 / 16	Transistor	175x107x87	2	4	2	2	YES	AC (DC)
LX3V-2416MR2H-A (D)	24 / 16	Mix	175x107x87	2	2	2	2	YES	AC (DC)
LX3V-2424MR-A (D)	24/ 24	Relay	220x107x87	2	0	2	2	YES	AC (DC)
LX3V-2424MT-A (D)	24 / 24	Transistor	220x107x87	2	2	2	2	YES	AC (DC)
LX3V-2424MT4H-A (D)	24 / 24	Transistor	220x107x87	2	4	2	2	YES	AC (DC)
LX3V-2424MR2H-A (D)	24 / 24	Mix	220x107x87	2	2	2	2	YES	AC (DC)
LX3V-3624MR-A (D)	36 / 24	Relay	220x107x87	2	0	2	2	YES	AC (DC)
LX3V-3624MT-A (D)	36 / 24	Transistor	220x107x87	2	2	2	2	YES	AC (DC)
LX3V-3624MT4H-A (D)	36 / 24	Transistor	220x107x87	2	4	2	2	YES	AC (DC)
LX3V-3624MR2H-A (D)	36 / 24	Mix	220x107x87	2	2	2	2	YES	AC (DC)

# LX3VP Series PLC Specifications

## LX3VP PLC Model

PLC Model	I/O	Output type	Dimension (mm)	Pulse Counter	Pulse Output	RS485	CAN	BD Board	Module	Power Supply
LX3VP-1208MR-A(D)	12 / 8	Relay	75x107x87	2	0	1	N/A	1	N/A	AC (DC)
LX3VP-1208MT-A(D)	12 / 8	Transistor	75x107x87	2	2	1	N/A	1	N/A	AC (DC)
LX3VP-1212MR-A(D)	12 / 12	Relay	137x107x87	2	0	2	N/A	1	YES	AC (DC)
LX3VP-1212MT-A(D)	12 / 12	Transistor	137x107x87	2	2	2	N/A	1	YES	AC (DC)
LX3VP-1212MT4H-A(D)	12 / 12	Transistor	137x107x87	2	4	2	N/A	1	YES	AC (DC)
LX3VP-1212MR2H-A(D)	12 / 12	Mix	137x107x87	2	2	2	N/A	1	YES	AC (DC)
LX3VP-1412MR-A(D)	14 / 12	Relay	137x107x87	2	0	2	N/A	1	YES	AC (DC)
LX3VP-1412MT-A(D)	14 / 12	Transistor	137x107x87	2	2	2	N/A	1	YES	AC (DC)
LX3VP-1412MT4H-A(D)	14 / 12	Transistor	137x107x87	2	4	2	N/A	1	YES	AC (DC)
LX3VP-1412MR2H-A(D)	14 / 12	Mix	137x107x87	2	2	2	N/A	1	YES	AC (DC)
LX3VP-1616MR-A(D)	16 / 16	Relay	175x107x87	2	0	2	N/A	2	YES	AC (DC)
LX3VP-1616MT-A(D)	16 / 16	Transistor	175x107x87	2	2	2	N/A	2	YES	AC (DC)
LX3VP-1616MT4H-A(D)	16 / 16	Transistor	175x107x87	2	4	2	N/A	2	YES	AC (DC)
LX3VP-1616MR2H-A(D)	16 / 16	Mix	175x107x87	2	2	2	N/A	2	YES	AC (DC)
LX3VP-2416MR-A(D)	24 / 16	Relay	175x107x87	2	0	2	Optional	2	YES	AC (DC)
LX3VP-2416MT-A(D)	24 / 16	Transistor	175x107x87	2	2	2	Optional	2	YES	AC (DC)
LX3VP-2416MT4H-A(D)	24 / 16	Transistor	175x107x87	2	4	2	Optional	2	YES	AC (DC)
LX3VP-2416MR2H-A(D)	24 / 16	Mix	175x107x87	2	2	2	Optional	2	YES	AC (DC)
LX3VP-2424MR-A(D)	24 / 24	Relay	220x107x87	2	0	2	N/A	2	YES	AC (DC)
LX3VP-2424MT-A(D)	24 / 24	Transistor	220x107x87	2	2	2	N/A	2	YES	AC (DC)
LX3VP-2424MT4H-A(D)	24 / 24	Transistor	220x107x87	2	4	2	N/A	2	YES	AC (DC)
LX3VP-2424MR2H-A(D)	24 / 24	Mix	220x107x87	2	2	2	N/A	2	YES	AC (DC)
LX3VP-3624MR-A(D)	36 / 24	Relay	220x107x87	2	0	2	N/A	2	YES	AC (DC)
LX3VP-3624MT-A(D)	36 / 24	Transistor	220x107x87	2	2	2	N/A	2	YES	AC (DC)
LX3VP-3624MT4H-A(D)	36 / 24	Transistor	220x107x87	2	4	2	N/A	2	YES	AC (DC)
LX3VP-3624MR2H-A(D)	36 / 24	Mix	220x107x87	2	2	2	N/A	2	YES	AC (DC)

# LX5V General Specifications

## LX5V PLC Model

Item	LX5V-1212MT/1412MT	LX5V-1616MT/2416MT	LX5V-2424MT/3624MT
Running Mode	Round Scan/ Interrupt		
Programming	Instruction List/ Ladder		
Total Instructions	Basic Instructions: 29 / Application Instruction: 170		
Execute time	Basic Instructions: 0.01-0.03μs		
System Flash	512KB/384KB(Ethernet Model)		
Download/ Monitoring	Serial Programming Cable (Serial Port) / Micro USB / Ethernet		
Ethernet	100M Ethernet (Optional)		
High Speed Pulse Output	Transistor: 4 channels / 200KHz	Transistor: 8 channels / 200KHz	Transistor: 8 channels / 200KHz
High speed counter interrupt	100 channels		
Timer Interrupt	100 Channels, Interruption time (min): 0.1ms		
External input interrupt	X0-X7 supports both rising and falling edges		
High Speed Input Single	4 Channels 150KHz	8 Channels 150KHz	8 Channels 150KHz
High Speed Input AB Phase	4 channel 100KHz, frequency modes:1/2/4 times	8 channel 100KHz, frequency modes:1/2/4 times	8 channel 100KHz, frequency modes:1/2/4 times
Power-down save	Adjusted by software		
Filter	For all X input terminals		
Serial Port	COM1: RS422 / RS485 COM2: RS485		
Temperature	Working Temperature : 0 ~ 55℃ / Storage Temperature : -20 ~ 70℃		
Humidity	35~ 85%RH (No condensation)		
Shock Resistance	JISC0040 Standard		
Influence Immunity	Meet the IEC61000-4-4 and GB/T 17626.4 standard: Noise voltage amplitude 1KVP-P , pulse width 10us, period 0.3 s, edge time 5ns , duration 1min.		
USB Supply	Use for upgrading firmware, downloading ladder diagram	N/A	Use for upgrading firmware, downloading ladder diagram

# LX5S General Specifications

## LX5S PLC Model

Item	LX5S-0806MT/MR LX5S-1208MT/MR	LX5S-1212MT/MR LX5S-1412MT/MR	LX5S-1616MT/MR LX5S-2416MT/MR	LX5S-2424MT/MR LX5S-3624MT/MR
Running Mode	Round Scan/ Interrupt / Event			
Programming	Instruction table/ladder diagram			
Total Instructions	Basic instruction: 29 / Application instruction: 170			
Execute time	Basic instruction 0.03-0.008μs			
System EMMC	512KB			
Download/ Monitoring	Programming cable (serial type) / Micro USB / Ethernet			
Ethernet	N/A	100M Ethernet (Optional)		
High Speed Pulse Output	Transistor type; 2 channels / 200KHz			
High speed counter interrupt	100 channel			
Timer Interrupt	100 channels, support 0.1ms interrupt			
External input interrupt	X0-X5 supports both rising and falling edges			
High Speed Input Single Phase	2 channel 150KHz; 4 channel 10KHz	2 channel 150KHz; 4 channel 10KHz	6 channel 150KHz	6 channel 150KHz
High Speed Input AB Phase	1 channel 100K Hz, supports 2 or 4 frequency multiplication 2 channels 10K Hz, supports 2 or 4 frequency multiplication	1 channel 100KHz, supports 2 or 4 frequency multiplication 2 channels 10K Hz, supports 2 or 4 frequency	3 channels 100KHz, supports 2 or 4 frequency multiplication	3 channels 100KHz, supports 2 or 4 frequency multiplication
Power-down save	Adjusted by software			
Filter	For all X input terminals			
Serial Port	COM1 (RS422),COM2 (RS485)		COM1 (RS422 / RS485) ,COM2 (RS485)	
Temperature	Working Temperature : 0 ~ 55℃ / Storage Temperature :-20 ~ 70℃			
Humidity	35~ 85%RH (Without condensation)			
Shock Resistance	JISC0040 Standard			
Influence Immunity	Meet the IEC61000-4-4 and GB/T 17626.4 standard: Noise voltage amplitude 1KVP-P , pulse width 10us, period 0.3 s, edge time 5ns , duration 1min.			
USB Supply	YES			

# PLC General Specifications

	LX3V Series	LX3VP Series
Running Mode	Round Scan/ Interrupt	
Programming	Instruction List/Ladder	
Total Instructions	Basic Instructions:27 / Application Instruction: 138	Application Instruction:140
Execute time	Basic Instructions: 0.06us / Applcation Instruction: 1~10u s	
System Flash	16K	64K
Download/ Monitoring	Serial Programming Cable (Serial Port) / Micro USB	
High Speed Pulse Output	Transistor: 2 channels (4 channel optional) / Relay N/A (2 channel optional)	
External Interrupt	6 Channels	
Timer Interrupt	3 Channels	
High Speed Input Single Phase	2 channels 200KHz, 4 channels 5KHz	
High Speed Input AB Phase	1 channel 100KHz, frequency modes:1/2/4 times; 1 channel 5KHz, frequency modes:1/2/4 times	
Holding Addresses	Adjustable	
Filter	For all X input terminals	
Serial Port	COM1 : RS422 or RS485 COM2 : RS485	
Temperature	Working Temperature : 0 ~ 55°C / Storage Temperature : -20 ~ 70°C	
Humidity	5~ 85%RH (Without condensation)	
Shock Resistance	JISC0040 Standard	
Influence Immunity	Meet the IEC61000-4-4 and GB/T 17626.4 standard: Noise voltage amplitude 1KVP-P , pulse width 10us, period 0.3 s, edge time 5ns , duration 1min.	

## Output

Item	Relay Output	Transistor Output
Output Mode	--	NPN
Input Power Supply	DC 24V	DC 24V
Output Circuit	<AC 250V or <DC 30V	DC 5~30V
COM Port Current	--	<0.1mA ( DC30V )
Insulation	Mechanical insolation	Optical Coupler insolation
Leak current	--	0.1mA/DC30V
Min.Load	--	DC 5V2mA
Max.Load	Resistive	2A point 8A COM port
	Inductive	80VA
	General	100W
ResponseTime	ON	<0.2ms
	OFF	<10ms (High-speed output terminal:<5us)

# PLC General Specifications

## AC Power Supply

Item	LX3V/LX3VP(≤26I/Os)	LX3V/LX3VP(>26I/Os)
Voltage	AC 85~265V 50 ~ 60Hz	
Power OutageTime	10ms	
Rush Current	<15A5ms / AC 100V; <30A5ms / AC 200V	
Power Fuse	250V 3.15A	250V 3.15A
Power Consumption	<35W	<60W
Power Output	DC 24V 850mA	DC 24V 700mA

## DC Power Supply

Item	LX3V/LX3VP PLC
Power Supply	DC 24V±10%
Power Outage Time	10ms
Power Fuse	250V 3.15A
Rush Current	<15A 1ms/DC 24V
Power Consumption	<30w(Not include the external power supply for modules)

# WECON Servo Drives



## Servo Applications

Infrared Stone Cutting Machine



### Smart Control

Real-time speed adjustment during cutting

### Multiple Functions

Various functions such as board cutting, multi-face chamfer, special shape, profiling, etc.

### High Response

High performance CPU  
Faster data reading  
Faster calculation and sampling speed

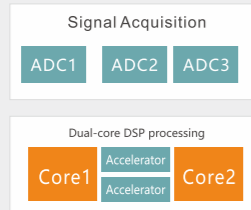

### Easy to Debug

Automatic load parameter tuning function

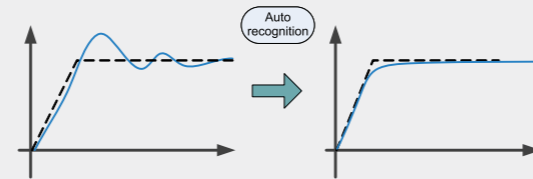

### Strong Protection

Coating protection, anti-corrosion.  
Rich protection functions, more stable.



### Personalise

Virtual DI/DO function, four-channel real-time oscilloscope.



### Support internal multi-speed instruction

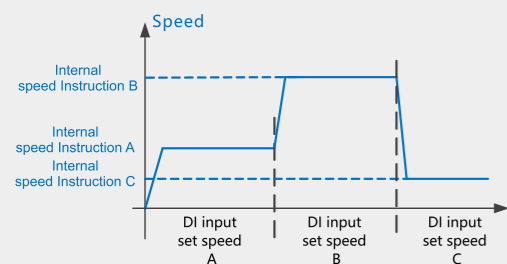

### Support internal multi-segment position instruction

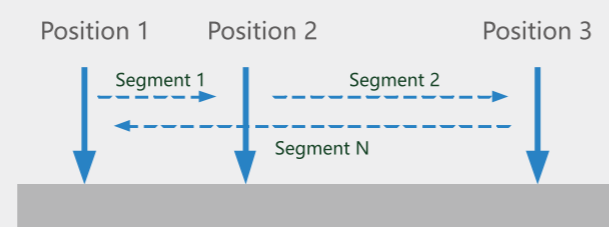

## Application

Automatic Plug Wiring Machine, Packaging Machinery, Cutting Machinery, Winding Machinery, Face Mask Machinery, Rubber Machinery, Automated Production Lines, Industrial Robots

### Automatic Plug Wiring Machine



### Automated Production Lines



### Industrial Robots



### Textile Machinery





# SERVO Naming Rules

## Drive Naming Rules

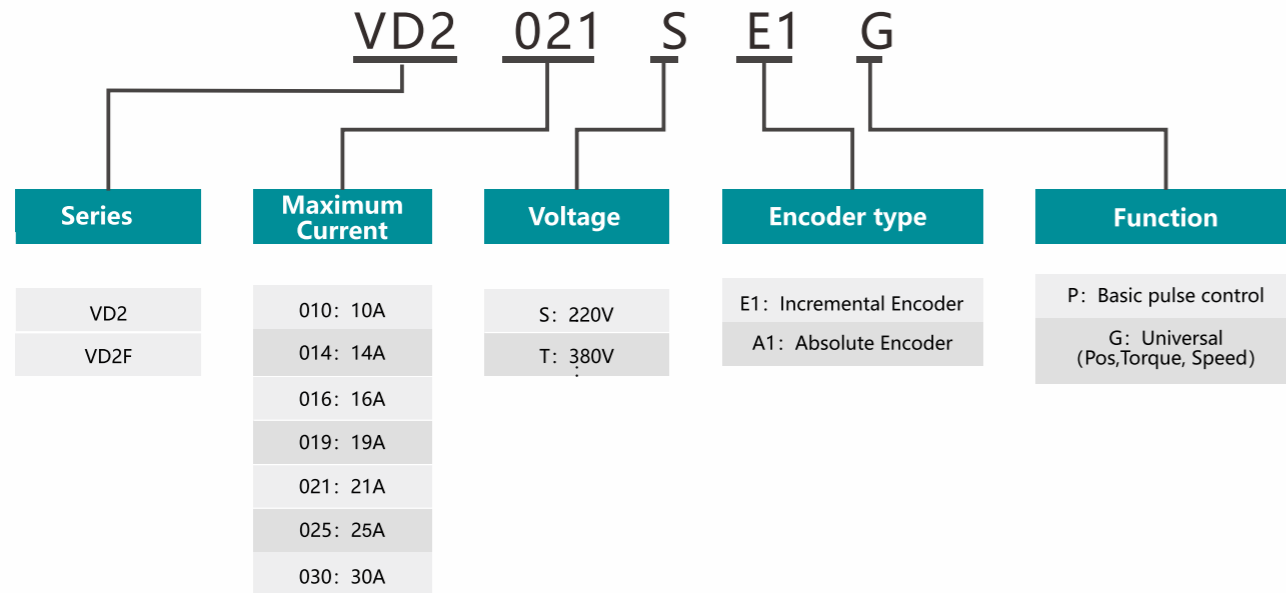

## Motor Naming Rules

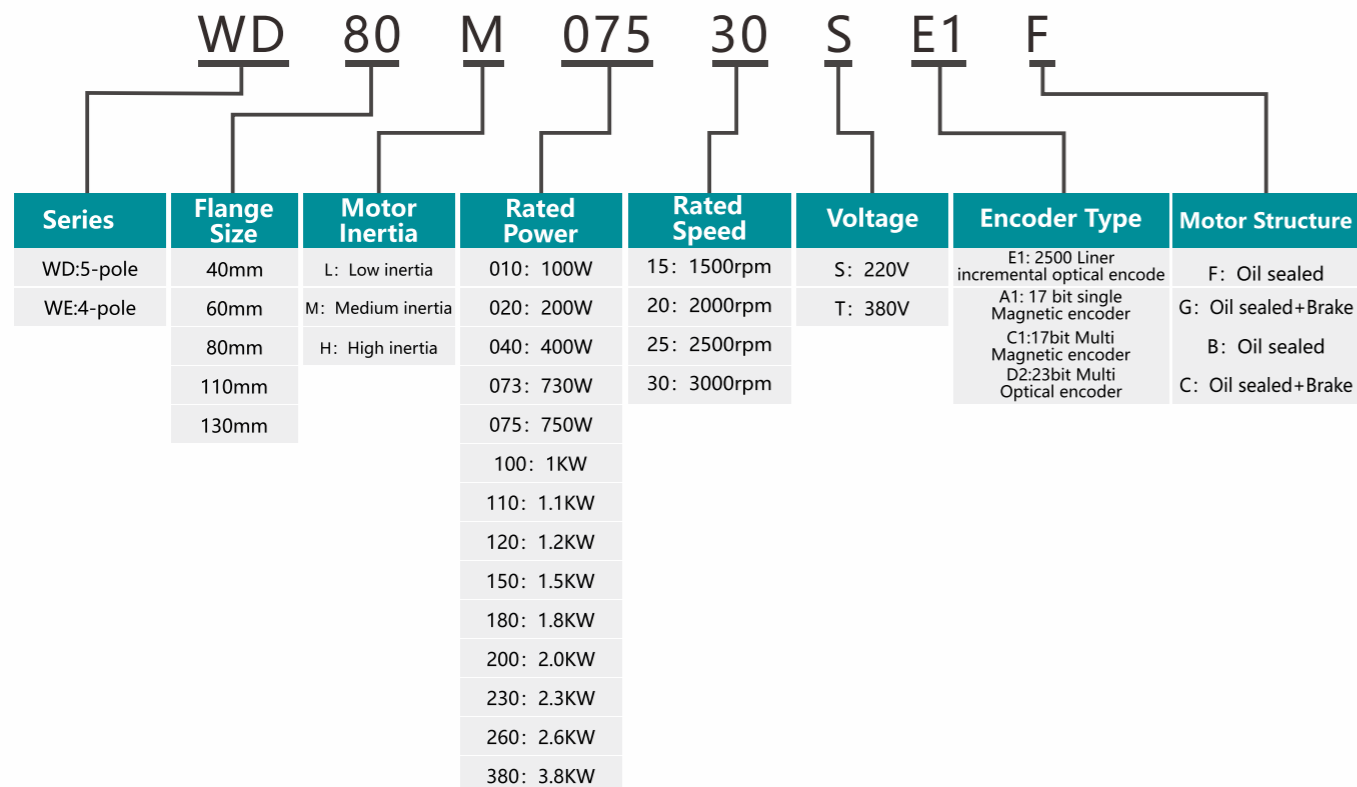

# VD2/VD2F Servo Drive & Motor Specifications

## VD2/VD2F Drives & Motors

▲ : A1-Absolute value; E1-Incremental.  
P : Pulse control; G: General (Pos,Torque,speed) .

Series	Type	Drive Model	Max Current(A)	Power Supply	Drive Model	Max Current(A)	Power Supply
VD2	A	VD2-010SA1G	10	220V	VD2-014SA1G	14	220V
	B	VD2-016S▲G	16	220V	VD2-019S▲G	19	220V
		VD2-021S▲G	21	220V	VD2-025SA1G	25	220V
		VD2-030SA1G	30	220V	VD2-021TA1G	21	380V
VD2F	F	VD2F-010SA1P	10	220V	VD2F-014SA1P	14	220V

### Note:

- VD2-XXXTA1G is not recommended to work in industrial three-phase voltages of 440V and above.
- For 380V operating voltage, the fluctuation range is 15%
- For 400V operating voltage, the fluctuation range is 10%

Series	Motor Model	Power Supply	Flange	Rated Power (kW)	Rated Torque (N.m)	Rated Speed (rpm)	Rated Current(A)	Max Torque (N.m)	
VD SERIES	WD40M-01030S○☆	220V	40	0.1	0.32	3000	1	0.95	
	WD60M-02030S○☆		60	0.2	0.64	3000	1.7	1.92	
	WD60M-04030S○☆			0.4	1.27	3000	2.5	3.81	
	WD80M-07530S○☆		80	0.75	2.39	3000	4.4	7.17	
VE SERIES	WE60M-04030S○☆		220V	60	0.4	1.27	3000	2.6	3.8
	WE80M-07320S○☆				80	0.73	3.5	2000	3
	WE80M-07530S○☆			0.75		2.39	3000	3	7.1
	WE80M-10025S○☆			1		4	2500	4.4	12
	WE80M-11030S○☆			1.1		3.5	3000	4	10.5
	WE80M-12030S○☆			1.2		4	3000	4.5	12
	WE110M-06030S○☆			110		0.6	2	3000	2.5
	WE110M-08020S○☆				0.8	4	2000	3.5	12
	WE110M-12020S○☆	1.2			6	2000	4.5	12	
	WE110M-15030S○☆	1.5			5	3000	6	15	
	WE110M-18030S○☆	1.8			6	3000	6	18	
	WE130M-10025S○☆	130			1	4	2500	4	12
	WE130M-10010S○☆		1		10	1000	4.5	20	
	WE130M-13025S○☆		1.3		5	2500	5	15	
	WE130M-15025S○☆		1.5	6	2500	6	18		
	WE130M-15015S○☆		1.5	10	1500	6	25		
	WE130M-20025S○☆		2	7.7	2500	7.5	22		
	WE130M-23015S○☆		2.3	15	1500	9.5	30		
	WE130M-26025S○☆		2.6	10	2500	10	25		
	WE130M-38025S○☆		3.8	15	2500	13.5	30		
WE130M-20025T○☆	380V		130	2	7.7	2500	6	18	
WE130M-26025T○☆				2.6	10	2500	6	25	
WE130M-38025T○☆				3.8	15	2500	7.5	22	
WE130M-42020T○☆		4.2		20	2000	8.5	60		
WE130M-53030T○☆		180	5.3	17	3000	9.5	30		
WE180M-30015T○☆			3	19	1500	10	25		
WE180M-43015T○☆			4.3	27	1500	13.5	30		
WE180M-45020T○☆			4.5	21.5	2000	9.5	53		
WE180M-55015T○☆	5.5	35	1500	13.5	30				

○ : A1-17 bit single Magnetic encoder C1-17bit Multi Magnetic encoder; D2-23bit Multi Optical encoder;

☆: F-Oil sealed; G-Oil sealed & Brake.

(Remarks: Please contact us for motor confirmation before purchase)

# VD2 Drive Specifications

Universal Type



Model	VD2(A)	VD2(B)
-------	--------	--------

Item		VD2 Series		
Basic Specifications	Power Supply	220V	220V/380V	
	Control Method	IGBT PWM controlled sine wave current drive		
	Encoder	2500ppr incremental encoder; 17 bit, 23 bit absolute encoder		
	Input Signal	8*DI		
	Output Signal	4*DO		
	Analog Signal Input	2*AI input(-10v~10v)		
	Pulse Signal Input	Open collector or differential input		
	Pulse Feedback Output	A,B,Z differential output		
	Internal Instructions	Support 8 internal speed commands and internal multi-segment position commands		
	Communication/Debug	Support to communicate with modbus device and debug with SCTools at the same time. (SCTools can set&monitor servo parameters,monitor waveform,self-tuning parameter,etc.)		
	Braking Resistor	400W without built-in baking resistor; both support external braking resistor		
	General Function	Self-tuning	SCTools supports self-tuning function,and identifies load inertia identification and rigidity level, and other parameters.	
Waveform Monitoring		View position, speed, torque and other curves on PC in real time		
Waveform Storage		The original waveform data could be stored for up to 10s		
Parameter Import / Export		Support batch parameter import and export; support PLC configurate servo parameters automatically (supported by some models)		
Vibration Suppression		Suppress mechanical vibration by setting vibration suppression parameters		
Protective Function		Overvoltage, undervoltage, overcurrent, overspeed, overload, overheating, encoder failure, excessive position deviation, torque limit, speed limit, etc		
Brake		Support		
Universal Control DI		Servo enable (SON), fault and warning clear (A-CLR), forward drive prohibition (POT), reverse drive prohibition (NOT), command reverse (C-SIGN), emergency stop (E-STOP), Gain switching (GAIN-SEL), Multi-speed command selection(INSPD1, INSPD2, INSPD3); Internal multi-position command selection and enable (POS1,POS2, POS3,POS4, POSEN)		
Function Setting	Universal Control DO	Servo ready (RDY), fault signal (ALM), warning signal (WARN), rotation detection (TGON), zero speed signal (ZSP), torque limit (T-LIMIT), speed limit (V-LIMIT),servo on state output (SRV-ST), servo brake output (BRK-OFF)		
	Pulse Input	Pulse Frequency	Maximum 500khz	
		Pulse Type	Pulse + Direction, CCW/CW pulse, Quadraturel encoding	
		Pulse Filtering	First-order low-pass filter or smooth filter	
		Pulse Output	Differential Quadraturel encoding A, B, Z output; PPR is settable by p0-16 or P0-17~P0-20.	
	Speed Mode	Command Input	-10V~+10V analog input internal speed command (Maximum 8)	
		Zero Clamp	Motor speed could be clamped to zero via the setting of zero clamp function	
		Torque Limit	Support to set the torque limit	
	Torque Mode	Command Input	-10V~+10V analog input and Internal torque command	
		Torque Reaching	Torque reaching threshold and DO can be set flexibly	
		Speed Limit	The speed limit can be set flexibly	

# VD2F Drive Specifications

Universal Type



Model	VD2F
-------	------

Item		VD2F Series	
Basic Specifications	Power Supply	220V	
	Control Method	IGBT PWM controlled sine wave current drive	
	Encoder	17 bit, 23 bit absolute encoder	
	Input Signal	4*DI	
	Output Signal	4*DO	
	Analog Signal Input	—	
	Pulse Signal Input	Open collector or differential input	
	Pulse Feedback Output	Z signal open collector output	
	Internal Instructions	Support 8 internal speed commands and internal multi-segment position commands	
	Communication / Debug	Support to communicate with modbus device or debug with SCTools	
	Braking Resistor	750W built-in baking resistor; 400W without built-in baking resistor; both support external braking resistor	
	General Function	Self-tuning	SCTools supports self-tuning function,and identifies load inertia identification and rigidity level, and other parameters.
Waveform Monitoring		View position, speed, torque and other curves on PC in real time	
Waveform Storage		The original waveform data could be stored for up to 10s	
Parameter Import / Export		Support batch parameter import and export; support PLC configurate servo parameters automatically (supported by some models)	
Vibration Suppression		Suppress mechanical vibration by setting vibration suppression parameters	
Protective Function		Overvoltage, undervoltage, overcurrent, overspeed, overload, overheating, encoder failure, excessive position deviation, torque limit, speed limit, etc	
Brake		Support	
Universal Control DI		Servo enable (SON), fault and warning clear (A-CLR), forward drive prohibition (POT), reverse drive prohibition (NOT), command reverse (C-SIGN), emergency stop (E-STOP), Gain switching (GAIN-SEL), Multi-speed command selection(INSPD1, INSPD2, INSPD3); Internal multi-position command selection and enable (POS1,POS2, POS3,POS4, POSEN)	
Function Setting	Universal Control DO	Servo ready (RDY), fault signal (ALM), warning signal (WARN), rotation detection (TGON), zero speed signal (ZSP), torque limit (T-LIMIT), speed limit (V-LIMIT),servo on state output (SRV-ST), servo brake output (BRK-OFF) ; Z signal input	
	Pulse Input	Pulse Frequency	Maximum 500khz
		Pulse Type	Pulse + Direction, Orthogonal coding
		Pulse Filtering	First-order low-pass filter or smooth filter
		Pulse Output	—
	Speed Mode	Command Input	Only internal speed command is supported (Maximum 8)
		Zero Clamp	Motor speed could be clamped to zero via the setting of zero clamp function
		Torque Limit	Support to set the torque limit
	Torque Mode	Command Input	Only internal torque command is supported
		Torque Reaching	Torque reaching threshold and DO can be set flexibly
		Speed Limit	The speed limit can be set flexibly

# WECON IIoT

## Products and Solutions

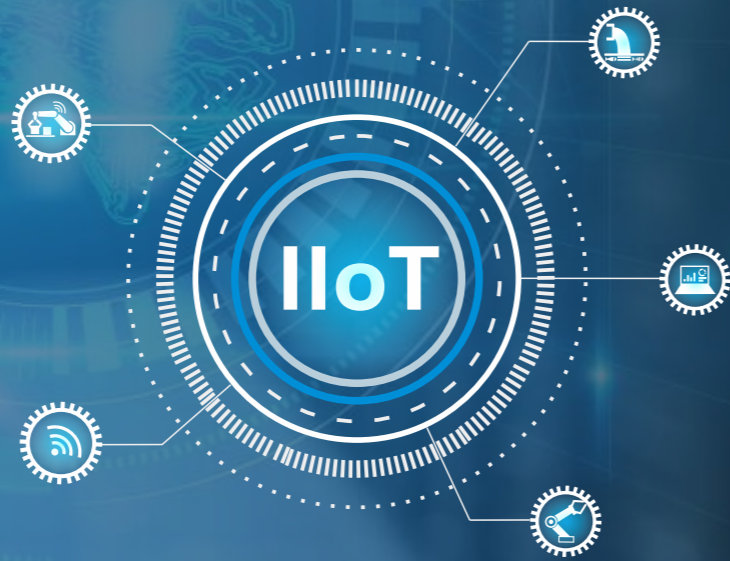

### WECON V-NET&Gateway Architecture

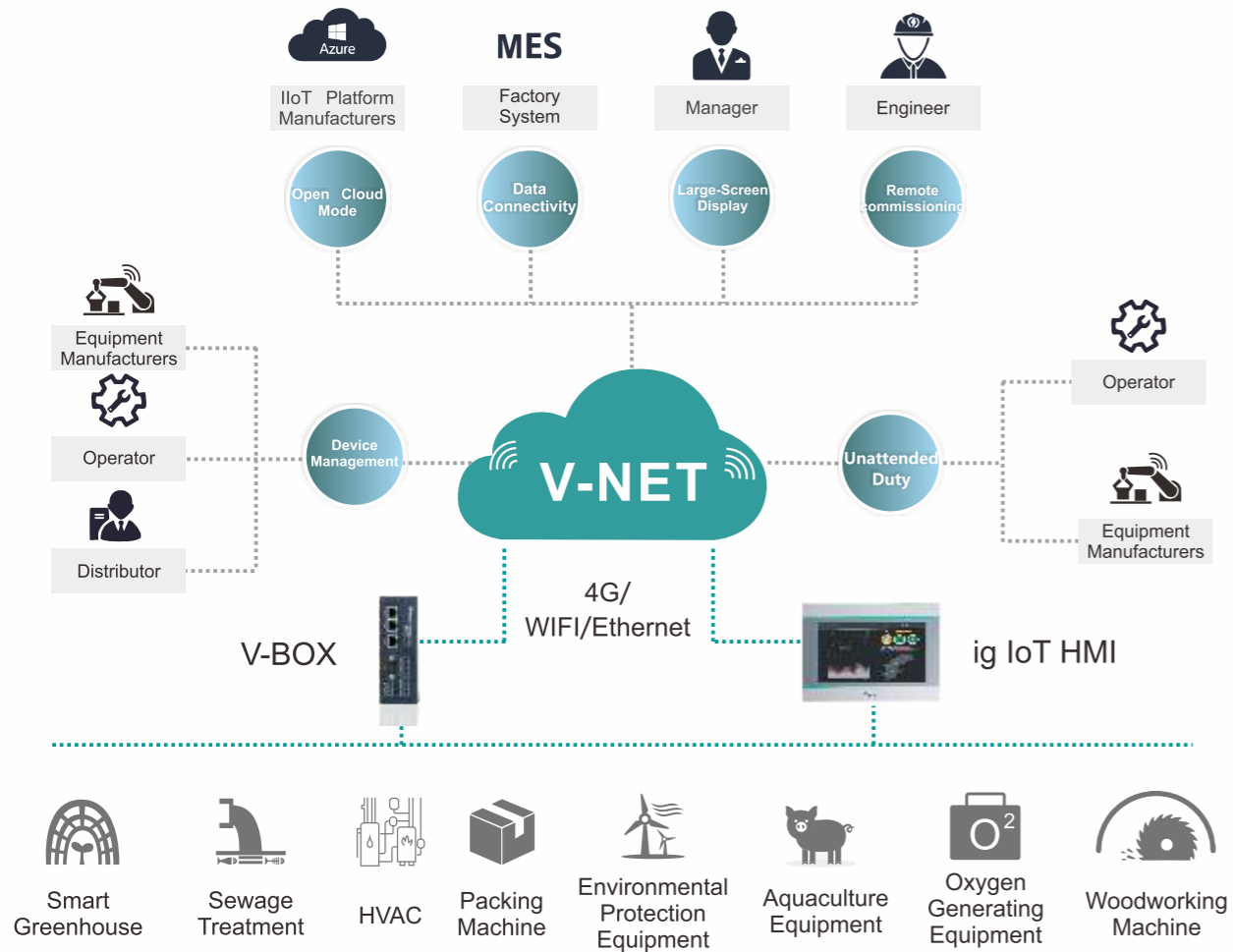

### WECON V-NET&Gateway Functions

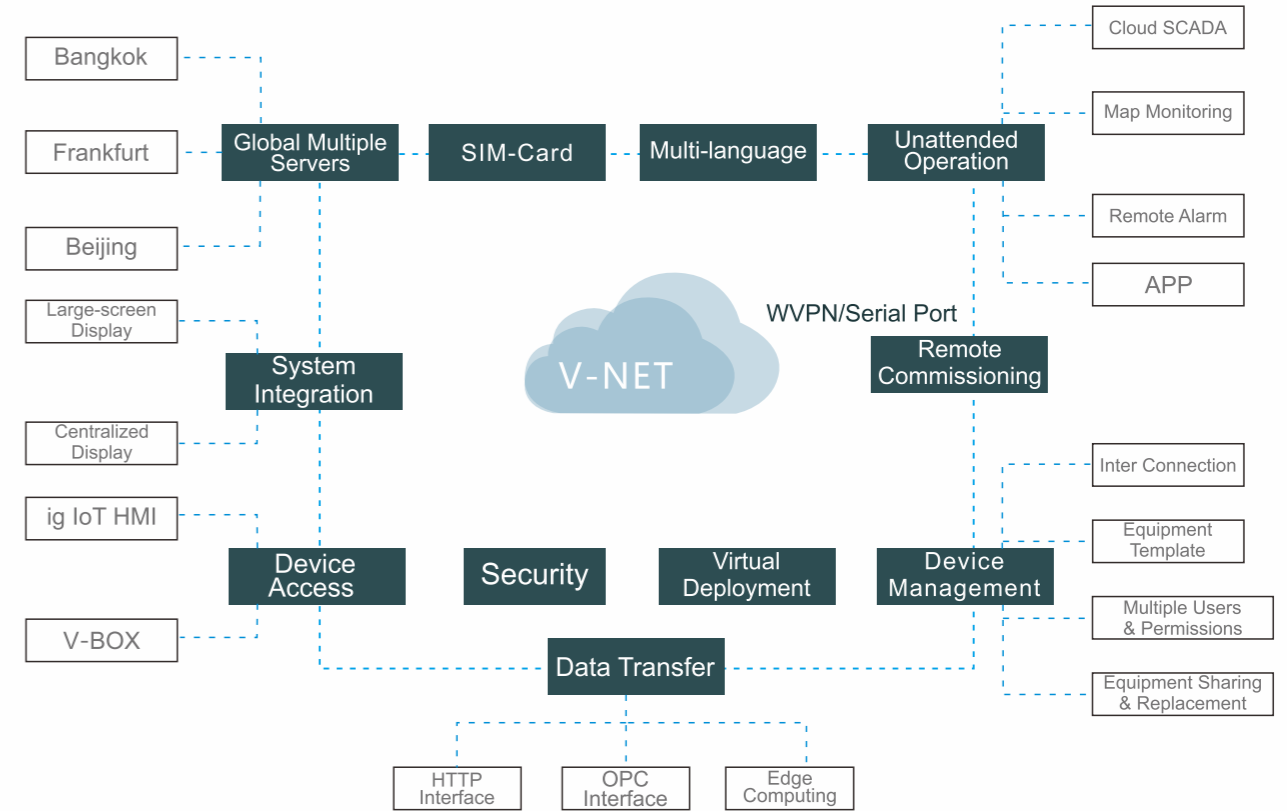

#### Device Management

##### All in One

To locate the devices accurately through map index, category search, fuzzy search, etc.

##### One-key Configuration

To download and modify the configuration of the V-BOX of the same model by using the template function.

##### Role Management

Managers can assign V-NET permissions to users at the corresponding levels by establishing users at various levels (4 levels in total), no matter how many devices there are, they could be managed by one person.

#### Global Servers

Server Location	Providers	Country or Region
Beijing	HUAWEI CLOUD	China
Bangkok	HUAWEI CLOUD	Southeast Asia, East Asia and Oceania
Frankfurt	AWS by Amazon	Europe, America, Middle East and India

#### Multilingual

- Chinese & English for main interface;
- User-defined three kinds of languages supported in project of Cloud SCADA;
- Languages switchable.

# WECON V-BOX



Standard with 3 Serial ports & 3 Ethernet (H Series), Support RS485/RS422, Optional for WiFi, 4G, GPS

## WECON Application Heating Detection System



### Digital

Collect the analog signals of the temperature, pressure and flow rate of the outlet water of the heat exchanger, and use PID to control the valve diameter of the heat exchanger and the rotation speed of the circulating pump to achieve the purpose of automatic temperature adjustment.

### Remote Access

Remotely set heating temperature, working period and working mode

### Intelligence

Real-time display on the map of the primary and secondary pipe outlet and inlet water temperature, as well as equipment operating status, to achieve unattended operation.

## V-NET Applications

Gas Pipelines, Machinery, Water Treatment, Energy Consumption Monitoring, Transportation, Smart Agriculture, Smart Public Toilets, Smart Aquaculture, Municipal/Construction Site Dust Prevention and Spray

### Built-in IOs



Built-in 2\*DI & 2\*DO relay (H Series only)

### Pass-through Function



Support WVPN Pass-through, Serial Port Pass-through to realize PLC remote debugging or download

### Edge Computing



Simple logic control could be realized by built-in Lua Script.

### OpenCloud Mode



V-BOX can be connected to third-party platforms through OpenCloud Mode.

### Protocols



300+ protocols of main brands PLC with ethernet and serial ports

### Installations



DIN rail & mounting Hole installation

### Quick Access



Connect to V-NET easily by plugging in network cables or IoT SIM card (China cloud only)

### Indicators



V-NET Connection indicator  
4G Signal Intensity indicator  
PLC Communication Status indicator

### Machinery



### Gas steam boiler



### Water Treatment



### Transportation



# V-BOX E Series Specifications

General			
Model		E-00	E-4G
Item	Specifications		
CPU	ARM 9		
Storage	Flash	128MB	
	RAM	DDRII 64MB	
	SD Card	N/A	
I/O Ports	USB	OTG: USB HOST/USB DEVICE	
	Serial Ports	COM1: RS232, RS422/RS485(2 in 1)	
	Ethernet	1 Ethernet Port	
	WIFI Module	N/A	
	4G Module	N/A	4G
Power	Power Supply	24V DC (12~28V DC)	
	Power Consumption	< 10W	
Dimension	Enclosure	Cold-rolled steel sheets	
	Dimension (W*H*D)	101.0mm*73.2mm*26.8mm	
	Wall Hanging Dimension	110.0mm*15.6mm	
	Weight (KG)	0.26	
Environment	Vibration Resistance	IEC61131-2 Standard	
	Storage Temperature	-20°C~70°C	
	Working Temperature	-10°C~60°C	
	Relative Humidity	10~85%RH (Non-condensing)	
CE Certification	CE Marked		
FCC Certification	FCC Class A Marked		
Real-time Monitoring Points	200	250	
Alarm Monitoring Points	50	100	
History Monitoring Points	20	50	
History Storage/Storage capacity	60 Days/1 Million		90 Days/1 Million
Normal Pass-through	YES		
WVPN Pass-through	N/A		
Edge Computing	N/A	YES	
API Interface	YES		
Remote Update	YES		
Configuration download / upload	YES		
Off-line Transmission	YES		
GPS	N/A	LBS	
E-4G model frequency code			
LTE FDD	LTE TDD	WCDMA	GSM
B1/B3/B5/B8	B34/B38/B39/B40/B41	B1/B5/B8	900/1800MHz

Remark: Please contact us for confirmation about 4G Compatibility before purchase.

# V-BOX H Series Specifications

General					
Model		H-00	H-WF	H-4G/H-SG	H-AG
Item	Specifications				
CPU	Cortex A7				
Storage	Flash	128MB			
	RAM	DDRIII 128MB			
I/O Ports	USB	HOST/DEVICE: USB OTG Switch			
	Serial Ports	COM1: RS232, RS422/RS485 (2 in 1) RS485(2 in 1) 【COM2: RS485, COM3: RS485】			
	Ethernet	3 Ethernet Ports			
	WIFI Module	N/A	YES	N/A	N/A
	4G Module	N/A	N/A	4G	4G (Global)
Power	I/O	2 inputs with optocoupler isolation; 2 relay outputs			
	Power Supply	24V DC (12~28V DC)			
Dimension	Power Consumption	< 10W			
	Enclosure	PC+ABS (			
	Dimension (W*H*D)	131.0mm*100.5mm*46.0mm			
Environment	Weight (KG)	0.3			
	Vibration Resistance	IEC61131-2 Standard			
	Storage Temperature	-20°C~70°C			
	Working Temperature	-10°C~60°C			
Relative Humidity	10~85%RH (Non-condensing)				
CE Certification	CE Marked				
FCC Certification	FCC Class A Marked				
Real-time Monitoring Points	300	300	500	600	
Alarm Monitoring Points	200	200	300	300	
History Monitoring Points	50	50	100	100	
History Storage/Storage capacity	90 Days/1 Million			180 Days/1 Million	
Normal Pass-through	YES				
WVPN Pass-through	YES	YES	YES	YES	
Edge Computing	YES				
API Interface	YES				
Remote Update	YES				
Configuration download / upload	YES				
Off-line Transmission	YES				
GPS	N/A	LBS/GPS		LBS	
H-4G model frequency code					
LTE FDD	LTE TDD	TD-SCDMA	WCDMA	CDMA	GSM
B1/B3/B5/B8	B34/B38/B39/B40/B41	B34/B39	B1/B8	BC0	900/1800MHz
H-AG model frequency code					
LTE FDD		LTE TDD		UMTS	GSM
B1/B2/B3/B4/B5/B7/B8/B12/B13/B18/ B19/B20/B25/B26/B28		B38/B39/B40/B41		B1/B2/B4/B5/B6/B8/B19	B2/B3/B5/B8

Remark: Please contact us for confirmation about 4G Compatibility before purchase.

# VB Series AC Drive

Power Range: Single Phase Input & Three Phase Output(220V): 0.75~2.2kW;  
 Three Phase Input & Three Phase Output (380V): 0.75~400kW

The VB series is a new high-performance vector general-purpose VFD that further enhances stability and reliability through technical upgrades and product optimization, and it is suitable for complex drives applications.



- SVC/VF Control
- 0-1000Hz
- 6 channels DI, 2 channels AI, 2 channels Relay
- High reliability design

## Application

Lifting machinery, tension machinery, cutting and forging machinery, large inertia braking, metal processing, woodworking, rubber and plastic machinery, textile machinery, etc.



## Technical specification sheet

Control characteristic	Control Mode	V/F Control; Sensorless Vector Control (SVC); Torque Control
	Starting Torque	G Type: 0.5Hz/150 % (SVC); P Type: 0.5Hz/100%
	Speed Adjustment Range	1 : 100 (SVC)
	Speed Holding Precision	± 0.5 % (SVC)
	Overload Capability	G Type: 150 % rated current for 60s ; 180 % rated current for 1s P Type: 120 % rated current for 60s ; 150 % rated current for 1s
Input/output	Input Voltage	220V/380V±15%
	Input Frequency	50/60Hz, fluctuation range: ±5%
	Output Voltage	0-rated input voltage
	Output Frequency	SVC: 0~320Hz, V/F: 0~1000Hz
Input/output Terminals	Analog Input	2 channels
	Digital Input	6 channels
	Analog Output	2 channels
	Digital Output	1 channels
	Relay Output	2 channels
	RS485 Communication Terminal	1 channels
	Power Supply	2 channels, 1 channels 10V,1 channels 24V
Application environment	Attitude	Lower than 1000m, service is derated capability above 1000m, derate 1% capacity every 100m increased in height
	Environment Temperature	-10°C ~ + 40°C (service is derated capability for 40°C ~ 50°C)
	Humidity	≤95%RH, no water condensation
	Vibration	< 5.9m/s <sup>2</sup> (0.6g)
	Storage Temperature	- 40°C ~ + 60°C

## Model number description

**VB - 4 T 18R5GB /022PB**

VB: Product Series				022: 22kW
2: 220VAC, 4: 380VAC				P: Variable Torque Load
S: Single phase, T: Three phase				B: Braking Unit Within
				18R5: 18.5kw R: Refers to Decimal Point
				G: Constant Torque Load B: Braking Unit Within

## ■ Specification and selection guide

Voltage grade	Power		Rated input current(A)	Rated output current(A)	Series No.	2:220V 4:380V	S:single phase T: three-phase	Adaptive motor power	G: general type P: fan type	B:integrated with brake function
	kW	HP								
Single phase 220VAC ±15%	0.75	1.0	8.2	4.5	VB	2	S	R75	G	B
	1.5	2.0	14	7	VB	2	S	1R5	G	B
	2.2	3.0	23	9.6	VB	2	S	2R2	G	B
Three phase 380VAC ±15%	0.75	1.0	3.4	2.1	VB	4	T	R75	G	B
	1.5	2.0	5	3.8	VB	4	T	1R5	G	B
	2.2	3.0	5.8	5.1	VB	4	T	2R2	G	B
	4/5.5	5.5/7.5	10.5/14.6	9/13	VB	4	T	4/5R5	G/P	B
	5.5/7.5	7.5/10	14.6/20.5	13/17	VB	4	T	5R5/7R5	G/P	B
	7.5	10.2	20.5	17	VB	4	T	7R5	G	B
	11/15	15/20	26/35	25/32	VB	4	T	011/015	G/P	B
	15/18.5	20/25	35/38.5	32/37	VB	4	T	015/18R5	G/P	B
	18.5/22	25/30	38.5/46	37/45	VB	4	T	18R5/022	G/P	B
	22/30	30/40	46.5/62	45/60	VB	4	T	022/030	G/P	B
	30/37	40/50	62/76	60/75	VB	4	T	030/037	G/P	/
	37/45	50/60	76/92	75/91	VB	4	T	037/045	G/P	/
	45/55	60/70	92/113	91/110	VB	4	T	045/055	G/P	/
	55/75	70/100	113/157	112/150	VB	4	T	055/075	G/P	/
	75/90	100/125	157/180	150/170	VB	4	T	075/090	G/P	/
	90/110	125/150	180/214	170/210	VB	4	T	090/110	G/P	/
	110/132	150/180	214/256	210/253	VB	4	T	110/132	G/P	/
	132/160	180/220	256/307	253/304	VB	4	T	132/160	G/P	/
	160/185	220/255	307/345	304/340	VB	4	T	160/185	G/P	/
	185/200	255/275	345/385	340/377	VB	4	T	185/200	G/P	/
200/220	275/300	385/430	377/426	VB	4	T	200/220	G/P	/	
220/250	300/340	430/468	426/465	VB	4	T	220/250	G/P	/	
250/280	340/380	468/525	465/520	VB	4	T	250/280	G/P	/	
280/315	380/430	525/590	520/585	VB	4	T	280/315	G/P	/	
315/355	430/480	590/665	585/650	VB	4	T	315/355	G/P	/	
355/400	480/545	665/785	650/725	VB	4	T	355/400	G/P	/	
400	545	785	725	VB	4	T	400	G	/	

## ■ Dimensions(mm)

### 0.75kW-7.5kW dimension

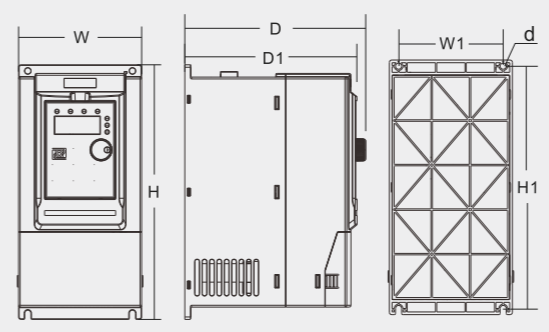

Inverter Model	Outline size				Installation dimension		Opening size
	H	W	D	D1	H1	W1	d
VB-2SR75GB	187	88	138	130	177	73	5
VB-2S1R5GB							
VB-2S2R2GB							
VB-4TR75GB							
VB-4T1R5GB							
VB-4T2R2GB	207	100	147	139	197	85	5
VB-4T004GB/5R5PB							
VB-4T5R5GB/7R5PB							
VB-4T7R5GB	247	130	167	159	237	113	5

### 11kW-185kW dimension

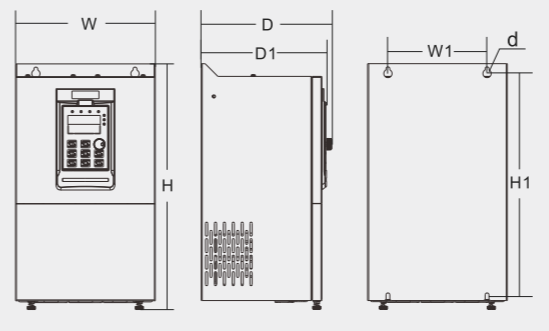

Inverter Model	Outline size				Installation dimension		Opening size
	H	W	D	D1	H1	W1	d
VB-4T011GB/015PB	348	182	211	196	331	156	6
VB-4T015GB/18R5PB							
VB-4T18R5GB/022PB							
VB-4T022GB/030PB	373	220	205	190	356	156	6
VB-4T030G/037P							
VB-4T037G/045P	435	256	222	208	419	170	6
VB-4T045G/055P							
VB-4T055G/075P	543	310	280	265	523	245	10
VB-4T075G/093P							
VB-4T093G/110P	580	358	328	314	560	270	10
VB-4T110G/132P							
VB-4T132G/160P	869	502	355	342	842	320	10
VB-4T160G/185P							
VB-4T185G/200P							

### 200kW-400kW dimension

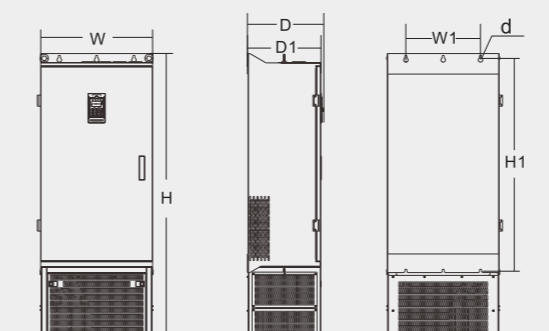

Inverter Model	Outline size				Installation dimension		Opening size
	H	W	D	D1	H1	W1	d
VB-4T200G/220P	1570	600	408	398	1147	400	12
VB-4T220G/250P							
VB-4T250G/280P							
VB-4T280G/315P	1696	800	408	398	1266	520	12
VB-4T315G/355P							
VB-4T355G/400P	1696	800	408	398	1266	520	12
VB-4T400G							

# IIoT Solutions

## Intelligent Water & Fertilizer Intergrated Pump Station

### Background

Water and Fertilizer Intergrated is a new agricultural technology that integrated management of irrigation and fertilization. It is based on pressure system to mix solid and liquid fertilizers, according to the soil nutrient content and the fertilizer requirements and characteristics of crop types. The fertilizer and water are mixed together to supply water and fertilizer by pipeline system. After the water and fertilizer are melted, irrigation is formed through pipes and spray guns or sprinklers to supply water and nutrients to crops regularly, quantitatively and evenly.

### Pain Points

- Unbalanced soil moisture and fertilizer, numerous of fertilization ratio data and tedious manual operation.
- Traditional fertilization is labor-intensive, time-consuming, and not in real time.
- It is not convenient for management with wide area of crop cultivation and large numbers of crops.

### Solution

Water & Fertilizer Intergrated devices aims to realize automatic irrigation and fertilization. Through the smart detection platform for biogas slurry and fertilizer configured by V-NET and Cloud SCADA, soil temperature and humidity data are uploaded in real time. Users can remotely view and monitor the Water & Fertilizer Intergrated devices by mobile phones or computers to make irrigation and fertilization more reasonable, so as to improve working efficiency.

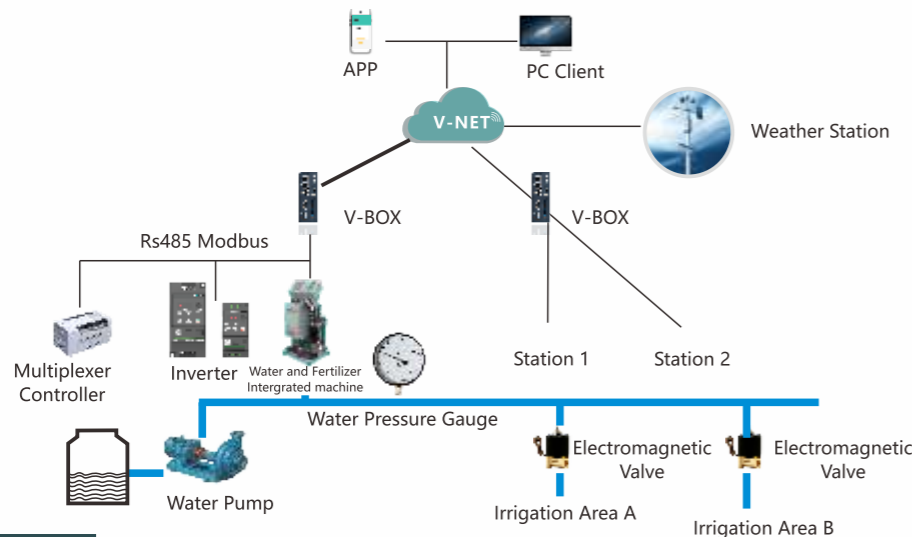

### Advantages

#### Unattended Operation

Real-time upload of temperature, humidity, water and fertilizer data through V-BOX or ig HMI, and visual management of the data in the form of graphs and curves.

#### Data Display

Real-time data monitoring of soil and crops, the remote opening of valves and the start and stop of timing rotation could be realized on V-NET, it can realize unattended irrigation, independent control, etc. It could prevent incorrect operation.

#### Alarm System

Real-time data monitoring of water pump current and voltage detection, outlet pressure, flow, etc., it could discover in time whether the irrigation system has unreasonable conditions such as water leakage, low pressure and broken pipes, also could send alarm messages in time to remind operator to carry out the maintenance so as to ensure the efficient operation of the irrigation system.

# IIoT Solutions

## Sewage Treatment Industry

### Background

With the development of the cities, the construction of hotels, residential departments and villas, the increased requirements for high quality life and a liveable environment, the sewage in the living area should be treated discharge. It requires a remote operation management platform to realize monitoring and automatic operation for domestic sewage treatment and realize unmanned management of equipment, to achieve the effect of centralized management of sewage purification, environment beautification, water and energy saving.

### Pain Points

- It is difficult to centralize design and management with widely distributed sewage water treatment in villages and towns.
- Engineers need to deal with it on site for devices unexpected failure, which time-consuming and labor-intensive.
- It is not easy to detect the device pressure value, flow value and other data, and the device is often overloaded and stop working.

### Solution

Through V-NET and Cloud Scada platform, Wecon IIoT gateway V-BOX could monitor and upload of devices data in real time, centralized monitoring and processing sensor data, remote download PLC program, and notify alarm messages in time. The start and stop of valves are remotely controlled by mobile phones and computers to realize centralized management of water treatment stations.

### Advantages

#### Unattended Operation

Real-time data monitoring of water volume and water quality of water pumps. Off-line transmission ensures that the data of the monitoring is always online and works stably in an unattended state.

#### Multi-Users Management

The supervisor account can authorize and manage accounts at different levels to protect data, management system and correct operation, ensuring the safe and orderly operation of the system.

#### Remote Operation

Centralized monitoring, remote commissioning, upgrade and maintain of water treatment devices without engineers on site. It would definitely reduce maintenance cost and improve management efficiently.

### Application

Domestic water supply, Industrial water treatment, Sewage treatment

